

DEFORMABLE MIRRORS & ADAPTIVE OPTICS SOLUTIONS

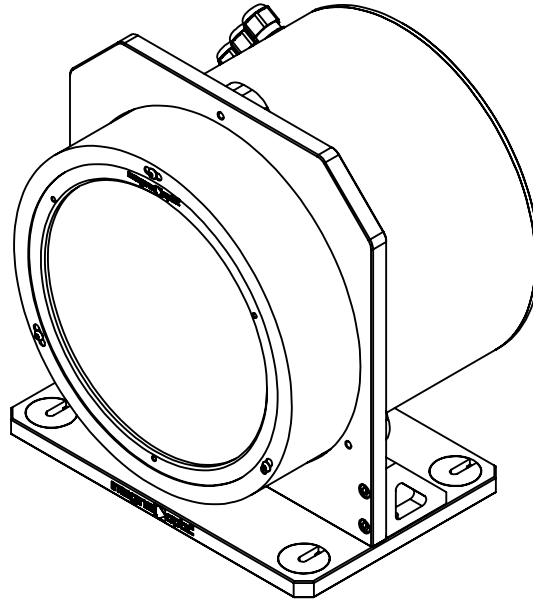

A 25-YEAR INNOVATION RUN

Index

+ Mechanical deformable mirrors	4
+ Electromagnetic deformable mirrors	6
+ Software solutions	8
+ Adaptive Optics solutions & kits	10

Imagine Optic 1st generation of Shack-Hartmann wavefront sensors was designed and manufactured in Orsay 25 years ago.

Coupling with **deformable mirrors** and constant updates were developed since the early 2000s, leading to the current 4th generation of **HASO**, covering an ever-broader range of applications for optical metrology and adaptive optics.

In 2020 the **LIFT** series added ultra-high resolution, bringing wavefront sensing on par with Fizeau interferometers for most applications.

Today, the **Optical Engineer Companion** connects Imagine Optic wavefront sensors and illumination modules, offering over 800 possible metrology setups.



Optical Engineer Companion



LIFT

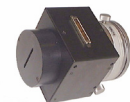

H-LINE

TWO DIFFERENT **ACTUATION TECHNOLOGIES**

Mechanical
Deformable mirrors

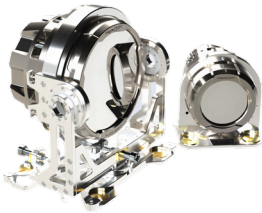

ILAO Star operates using the patented mechanical actuators offering astatic-floating heads that perform wavefront shaping with nanometric precision.

This actuation technology allows linearity >95% and offers extremely high stability.
The DM can be turned off once the optimal shape is achieved.

Electromagnetic
Deformable mirrors



Mirao 52e family and mu-DM deformable mirrors are based on electromagnetic actuation technology, providing large stroke, no hysteresis and exceptional linearity.

High stability versions are available for long term experiments.

MECHANICAL DEFORMABLE MIRRORS



**ILAO STAR
(STANDARD PRODUCT RANGE)**

Product name	Number of actuators	Beam size
ILAO STAR 50	19	16-25 mm
ILAO STAR 100	19-37	25-50 mm
ILAO STAR 150	37	50-80 mm
ILAO STAR 200	37-52	80-120 mm
ILAO STAR 250	52	120-170 mm

APPLICATIONS

ILAO STAR is the perfect deformable mirror for:

- + Focal spot correction
- + Wavefront precompensation
- + Particle acceleration
- + High harmonic generation
- + Laser fusion
- + **Aberration correction at full power mode**

Imagine Optic works closely with you to customize ILAO STAR deformable mirrors in order to achieve the best possible corrections according to your laser beam characteristics.

Following parameters are subject to customization:

- + beam size: from 20 to 500mm
- + intensity profile: Gaussian, super-Gaussian, or top hat
- + beam shape: circular, elliptical, square, or rectangular
- + incident angle: 0° , 45° , or other
- + coating: dielectric, metallic, or hybrid
- + environment: ambient or vacuum
- + spatial frequency correction: the number of actuators is optimized to achieve the 4th, 6th, 8th or even higher order Zernike polynomials correction



ELECTROMAGNETIC DEFORMABLE MIRRORS

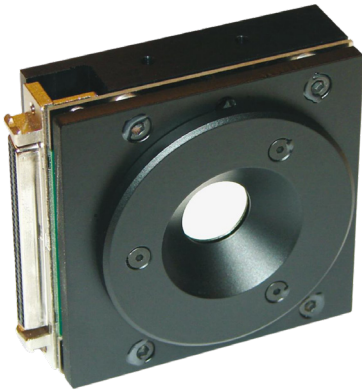

Mirao 52e

- + Designed for closed loop
- + Large amplitude



Mirao 52ep (protected version)

- + Protection against dust & mechanical damage to membrane

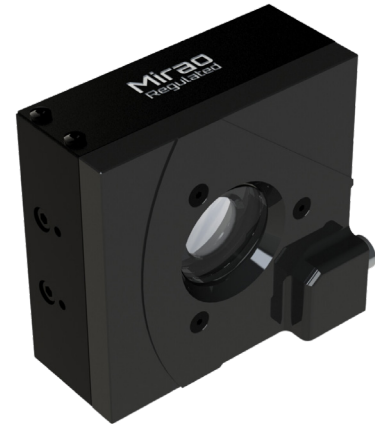

Mirao 52es (stabilized version)

- + Long term stability to allow open-loop operation

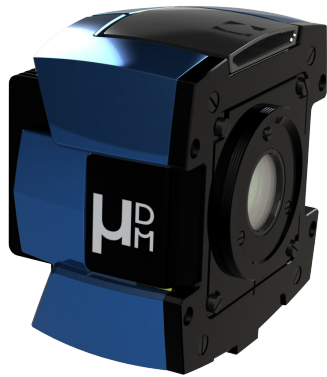

mu-DM

- + Embedded electronics
- + 91 actuators in a circular pattern

APPLICATIONS

- + **Ophthalmology :**
Explore retinal cells at high resolution (contact our sister company Imagine Eyes for more informations)
- + **Microscopy :**
Image deeper in your sample and/or navigate in 3D (for more details visit mu-Imagine website, our division dedicated to microscopy)
- + **Laser processing**
- + **Astronomy**
- + **Quantum**
- + **Education**

SOFTWARE SOLUTIONS



WAVETUNE Adaptive Optics Software

WAVETUNE™ software seamlessly combines wavefront measurement and correction features with extensive instrument diagnostics. It is perfectly adapted to a wide variety of active optics, including ILAO Sta, Mirao, mu-DM and Spatial Light Modulators (SLM).

Options :

+ Optional SDK in C/C++, LabVIEW and Python



PHARAO A WAVETUNE software extension

Fully correct beamline aberrations
up to user focal plane thanks to
PharAO.

It is a unique kit featuring a Phase
Retrieval algorithm combined with
a camera to correct transport and
focusing optics aberrations, in
vacuum or ambient environment.



ADAPTIVE OPTICS SOLUTIONS



Adaptive optics kits :

Get All the main components of an adaptive optics system from a single supplier :

- + HASO4 wavefront sensor
- + One of Imagine Optic deformable mirrors or a compatible SLM of your choice
- + WAVETUNE adaptive optics software



AO Kit ILAO STAR

- + Reliable adaptive optics solutions for ultra-high intense lasers
- + Includes PHARAO extension



AO Kit BIO

- + Dedicated to microscopy and vision science applications (more details on our division's website : www.mu-imagine.com)

CIAO VIS

Adaptive Optics add-on for telescope :

By removing static aberrations due to mirrors misalignment, thermal or gravity effects and by reducing the effect of air turbulence, CIAO improves the resolution of images or increases the coupling efficiency in a single mode fiber.

Connecting directly to the telescope eyepiece, CIAO is inserted between the telescope's focal plane and the user plane (sensor or fiber holder) without modifying the optical path.

Set up is facilitated by the embedded tip-tilt alignment interface and autocalibration tools.

After pointing on the target, the user can close the Adaptive Optics loop with a simple click, to activate the aberrations correction or to lock in very fine pointing.

CIAO VIS APPLICATIONS

- + High resolution imaging on planets or solar surface thanks to its compatibility with extended source
- + Stellar interferometry
- + High performance spectrometry
- + Space Situational Awareness (SSA)

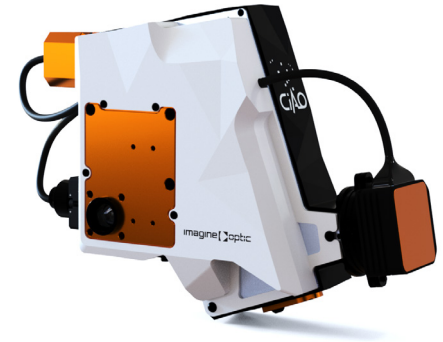

SWIR version coming 2025 !

SERVICES

All our hardware equipment comes with complementary services:

- + **Installation** assistance by our technicians and engineers
- + **Training** on both software and hardware, on site or remote
- + **Support** through our Zendesk-powered interface featuring FAQs, troubleshooting and other useful resources as well as a customer login and assistance system with a > 90 % satisfaction rating

Imagine Optic also provides on-demand services :

- + **Recalibration** of HASO wavefront sensors
- + **Equipment rental**
- + **Characterization** of optical components and systems
- + **Custom** optical metrology and adaptive optics benches

FOLLOW US

imagine-optic 

@imagineoptic 

@wavefrontrunners 



CONTACT US

Imagine Optic Headquarters

18, rue Charles de Gaulle
91400 ORSAY · France

Phone +33 (0)1 64 86 15 60
sales@imagine-optic.com
www.imagine-optic.com

